

Contents

Basics.....	82
Selection guide for syringe filters.....	84
CHROMAFIL® combi filters.....	85
CHROMAFIL® syringe filters.....	86
Chemical compatibility of CHROMAFIL®.....	93
CHROMAFIL® filtration cartridges · MULTI 96.....	94

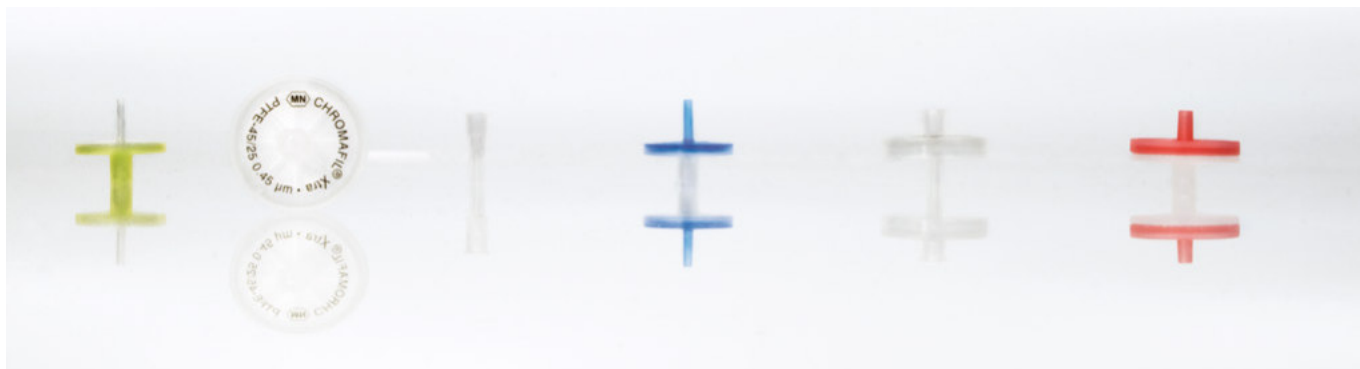
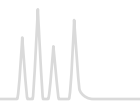

Sample filtration

Syringe filters are used for filtration of suspended matter from liquid samples or gases. With CHROMAFIL® rapid purification and removal of particles is very simple: just place the filter on the syringe and you are ready for filtration. Special manipulations are not required. The contamination of sensitive instrumentation by solid impurities can be avoided, which leads to an increase of lifetime of chromatographic columns and equipment.

Advantages

Polypropylene housing

- Considerably better solvent stability compared to acrylate and polystyrene filters, featuring a low content of extractable substances

Lowest content of extractable substances

- The housing of every CHROMAFIL® filter is ultrasonically sealed (welded), not glued, because glue may have extractable ingredients. Welding leads to a tight connection between both parts, thus the filter can be used in both directions. The special thick rim of the housing is ideal for use in laboratory robots (e.g., SOTAX®, Benchmate™).

Luer lock on the side of entry

- For a safe connection on the high-pressure side every filter provides a Luer lock on the side of entry.

Luer exit

- For 3, 13 and 25 mm filters: standard Luer exit
- For 15 mm filters: minispike · This Luer configuration offers a low hold-up volume and easy filtration into autosampler vials and NMR tubes.
- With the aid of a special adapter, filter inlet and filter exit can be fitted to all CHROMABOND® columns and accessories for selective sample preparation.

No rupture of membrane due to the impact plate

- The input solvent stream is broken and distributed by the impact plate and does not directly hit the membrane: this prevents rupture of the membrane. The high pressure stream is diverted into four lanes.

Optimum flow geometry because of the starshaped distribution device

- The stream of liquid is broken into 4 lanes by the impact plate and then further distributed to 8 slots in the form of a star connected with 5 or 8 circular channels (for 13, 15 and 25 mm filters, respectively). Thus, the fluid is able to penetrate the membrane on the whole surface, not only on a small region; the filter is not plugged up rapidly, which results in a high-flow efficiency.

Color coded filters

- Filters with 0.2 µm pores have a yellow upper shell, that of filters with 0.45 µm pores is colorless; the different membrane types are distinguished by different colors of the lower shell.

Different pore sizes for versatile filtration

- Standard pore sizes 0.2 and 0.45 µm (additionally: PET filters with 1.2 µm, glass fiber filters with 1 µm, PES filters with 5 µm). Filters with 0.45 µm pore size efficiently remove fine particles that can plug chromatography columns. Filters with 0.2 µm pore size are excellent for filtration of UHPLC samples or other techniques requiring high purity samples.

Filter sizes

- 3, 13, 15 and 25 mm diameter: the small diameter filters are especially recommended for very small samples, which require extremely low dead volumes: 5 µL for 3 mm Ø, 30 µL for 13 mm Ø, 35 µL for 15 mm Ø, 80 µL for 25 mm Ø

Recommended filter size depending on sample volume

Sample volume	Recommended filter diameter
≤ 1 mL	3 mm
1–5 mL	13 mm, 15 mm
5–100 mL	25 mm

Filters can be autoclaved at 121 °C, 1.1 bar for 30 min.

All 25 mm CHROMAFIL® filters are designed to be 100 % compatible and reliable for use with the SOTAX® AT70 smart fully automated dissolution testing systems.

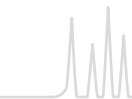

Depending on your filtration task you can choose filter membranes made from different materials:

Material	Page
Combi filters with glass fiber prefilters	
Polyester (GF/PET)	85
Regenerated cellulose (GF/RC)	85
Polyvinylidene difluoride (GF/PVDF)	85
Syringe filters without prefilters	
Polyester (PET)	86
Regenerated cellulose (RC)	87
Polytetrafluoroethylene (PTFE)	88
Hydrophilized polytetrafluoroethylene (H-PTFE)	88
Cellulose mixed esters (MV)	89
Cellulose acetate (CA) · sterile and non-sterile	89
Polyamide / Nylon (PA)	90
Polyethersulfone (PES)	90
Polyvinylidene difluoride (PVDF)	91
Glass fiber (GF)	91
Special filter for ion chromatography (IC)	92

CHROMAFIL® BIGbox

- 400 color-coded quality syringe filters or 400 labeled Xtra syringe filters (25 mm)
- Food safe PE box with screw cap

CHROMAFIL® Xtra

Labeled for method validation and certification

- Xtra: imprint for direct identification of the membrane type, diameter and pore size
- Xtra: low bleeding PP housing
- Xtra: color-free plain polypropylene



CHROMAFIL® combi filters

Combi syringe filters with a coarse glass fiber prefilter and a small pore membrane as main filter

User benefits:

- For solutions with a high load of particulate matter: lower back pressure, easy filtration
- For high yields of filtrate: more mL of pure filtrate per filter

The technology

The glass fiber membrane (1.0 µm) removes coarse particles, before they can block the fine main membrane. This results in a better filtration efficiency, especially for highly contaminated samples.

- Housing: Solvent-resistant, ultra low bleeding polypropylene
- Inlet: Luer lock
- Exit: Luer
- Pore size: 1.0/0.20 µm or 1.0/0.45 µm
- Filter diameter: 25 mm
- Dead volume: < 80 µL
- Packing unit: 100 filters; BIGbox with 400 filters

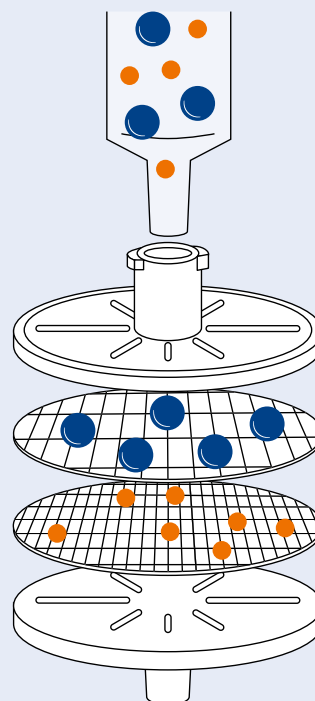



Selection guide for syringe filters

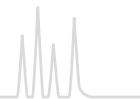

How to select the optimal CHROMAFIL® syringe filter

1. Filter size

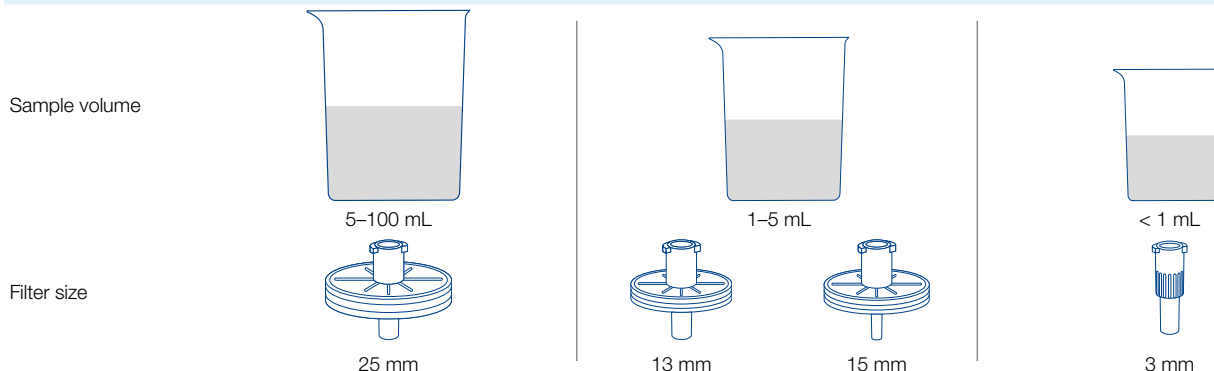

2. Pore size of filter membrane

Sample size

For general purpose
HPLC columns packed with particles
≥ 3 µm, GC, SFC, ...

Recommended for
UHPLC-, core-shell and HPLC columns,
packed with particles ≤ 3 µm, GC, SFC, ...



0.45 µm



0.20 µm

3. Membrane type

Properties of sample	Recommended	Alternatives		
Aqueous, polar hydrophilic low particle-load	PET	H-PTFE	MV	RC
high particle-load prefiltration required	GF/PET	GF/RC	GF/PVDF	
Mid-polar e.g. HPLC eluents	PET	PA	RC	
Proteins				
low binding capacity of proteins	CA	PVDF	PES	
high binding capacity of proteins	GF	GF/PET	GF/PVDF	
Strong acids and bases	H-PTFE	PTFE		
Organic, nonpolar, hydrophobic				
low particle-load	PTFE	PET		
high particle-load prefiltration required	GF/PET	GF/PVDF		
Aqueous, for ion chromatography determinations	IC			



MACHEREY-NAGEL

FilterFinder · easy switching to first-class filters

It is that simple

1. Choose previously used manufacturer
2. Choose previously used part number
3. Start searching
4. Suitable CHROMAFIL® syringe filter will be suggested

Use our FilterFinder online at www.mn-net.com/filterfinder





Polyester with glass fiber prefilter (GF/PET)



★ Key features

- Hydrophilic multipurpose membrane
- For polar as well as nonpolar samples
- The HPLC filter with glass fiber prefilter, especially suited for mixtures of water and organic solvents
- Recommended for solutions with a high load of particulate matter or for highly viscous samples. Glass fiber exhibits a high protein-binding capacity.

Ordering information

Type	Pore size [µm]	Membrane diameter [mm]	Color code		Standard pack		BIGbox	
			Top	Bottom	Filters/Pack	REF	Filters/Pack	REF
GF/PET-20/25	1.0/0.20	25	blue	orange	100	729032	400	729032.400
GF/PET-45/25	1.0/0.45	25	black	orange	100	729033	400	729033.400

Regenerated cellulose with glass fiber prefilter (GF/RC)



★ Key features

- Hydrophilic membrane
- For aqueous and organic-aqueous liquids, i.e. polar and medium polar sample solutions
- Recommended for solutions with a high load of particulate matter or for highly viscous aqueous solutions. Glass fiber exhibits a high protein-binding capacity.

Ordering information

Type	Pore size [µm]	Membrane diameter [mm]	Color code		Standard pack		BIGbox	
			Top	Bottom	Filters/Pack	REF	Filters/Pack	REF
GF/RC-20/25	1.0/0.20	25	blue	blue	100	729050	400	729050.400
GF/RC-45/25	1.0/0.45	25	black	blue	100	729051	400	729051.400

Polyvinylidene difluoride with glass fiber prefilter (GF/PVDF)



★ Key features

- Hydrophilic membrane
- Recommended for the filtration of biological samples with high particle loads. Glass fiber exhibits a high protein-binding capacity.
- Also suited for the filtration of aqueous samples

Ordering information

Type	Pore size [µm]	Membrane diameter [mm]	Color code		Standard pack		BIGbox	
			Top	Bottom	Filters/Pack	REF	Filters/Pack	REF
GF/P-45/25	1.0/0.45	25	black	white	100	729039	400	729039.400

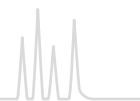

Polyester (PET)



★ Key features

- Hydrophilic multipurpose membrane
- For polar as well as nonpolar solvents
- The HPLC filter, especially suited for mixtures of water and organic solvents
- For TOC/DOC determination
- Not cytotoxic, does not inhibit the growth of microorganisms and higher cells

Ordering information

Type	Pore size [µm]	Membrane diameter [mm]		Standard pack		BIGbox	
				Filters/Pack	REF	Filters/Pack	REF
CHROMAFIL[®] Xtra							
PET-20/13	0.20	13	labeled	100	729222		
PET-45/13	0.45	13	labeled	100	729223		
PET-20/25	0.20	25	labeled	100	729221	400	729221.400
PET-45/25	0.45	25	labeled	100	729220	400	729220.400
PET-120/25	1.2	25	labeled	100	729229	400	729229.400

Type	Pore size [µm]	Membrane diameter [mm]	Color code		Standard pack		BIGbox	
			Top	Bottom	Filters/Pack	REF	Filters/Pack	REF
CHROMAFIL[®]								
PET-20/15 MS	0.20	15	yellow	orange	100	729022		
PET-45/15 MS	0.45	15	colorless	orange	100	729023		
PET-20/25	0.20	25	yellow	orange	100	729021	400	729021.400
PET-45/25	0.45	25	colorless	orange	100	729020	400	729020.400

MS = minispikes on filter exit



Regenerated cellulose (RC)



★ Key features

- Hydrophilic membrane with very low adsorption
- For aqueous and organic-aqueous liquids, i.e. polar and medium polar sample solutions
- Binding capacity for proteins 84 µg per 25 mm filter

Ordering information

Type	Pore size [µm]	Membrane diameter [mm]	Standard pack		BIGbox			
			Filters/Pack	REF	Filters/Pack	REF		
CHROMAFIL[®] Xtra								
RC-20/13	0.20	13	labeled	100	729236			
RC-45/13	0.45	13	labeled	100	729237			
RC-20/25	0.20	25	labeled	100	729230	400	729230.400	
RC-45/25	0.45	25	labeled	100	729231	400	729231.400	
Type	Pore size [µm]	Membrane diameter [mm]	Color code		Standard pack		BIGbox	
			Top	Bottom	Filters/Pack	REF	Filters/Pack	REF
CHROMAFIL[®]								
RC-20/15 MS	0.20	15	yellow	blue	100	729036		
RC-45/15 MS	0.45	15	colorless	blue	100	729037		
RC-20/25	0.20	25	yellow	blue	100	729030	400	729030.400
RC-45/25	0.45	25	colorless	blue	100	729031	400	729031.400

MS = minispikes on filter exit

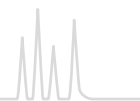

Polytetrafluoroethylene (PTFE)



★ Key features

- Hydrophobic membrane
- For nonpolar liquids and gases
- Very resistant towards all kinds of solvents as well as acids and bases
- Flushing with alcohol, followed by water, makes the original hydrophobic membrane more hydrophilic

Ordering information

Type	Pore size [μm]	Membrane diameter [mm]	Standard pack		BIGbox	
			Filters/Pack	REF	Filters/Pack	REF
CHROMAFIL[®] Xtra						
PTFE-20/13	0.20	13	labeled	100	729208	
PTFE-45/13	0.45	13	labeled	100	729209	
PTFE-20/25	0.20	25	labeled	100	729207	400 729207.400
PTFE-45/25	0.45	25	labeled	100	729205	400 729205.400
PTFE-100/25	1.0	25	labeled	100	729247	

Type	Pore size [μm]	Membrane diameter [mm]	Color code		Standard pack		BIGbox	
			Top	Bottom	Filters/Pack	REF	Filters/Pack	REF
CHROMAFIL[®]								
O-20/3	0.20	3	colorless	colorless	100	729014		
O-45/3	0.45	3	colorless	colorless	100	729015		
O-20/15 MS	0.20	15	yellow	colorless	100	729008		
O-45/15 MS	0.45	15	colorless	colorless	100	729009		
O-20/25	0.20	25	yellow	colorless	100	729007	400	729007.400

MS = minispikes on filter exit

Hydrophilized polytetrafluoroethylene (H-PTFE)



★ Key features

- Hydrophobic membrane with additional hydrophilic characteristic
- For polar and nonpolar solutions
- Resistant towards all kinds of solvents as well as acids and bases

Ordering information

Type	Pore size [μm]	Membrane diameter [mm]	Standard pack		BIGbox	
			Filters/Pack	REF	Filters/Pack	REF
CHROMAFIL[®] Xtra						
H-PTFE-20/13	0.20	13	labeled	100	729256	
H-PTFE-45/13	0.45	13	labeled	100	729257	
H-PTFE-20/25	0.20	25	labeled	100	729245	
H-PTFE-45/25	0.45	25	labeled	100	729246	400 729246.400



Cellulose mixed esters (MV)



★ Key features

- Hydrophilic membrane with very low adsorption
- For aqueous or polar solutions

Ordering information

Type	Pore size [µm]	Membrane diameter [mm]	Standard pack		BIGbox			
			Filters/Pack	REF	Filters/Pack	REF		
CHROMAFIL[®] Xtra								
MV-20/25	0.20	25	labeled	100	729206			
MV-45/25	0.45	25	labeled	100	729204	400	729204.400	
Type	Pore size [µm]	Membrane diameter [mm]	Color code		Standard pack		BIGbox	
			Top	Bottom	Filters/Pack	REF	Filters/Pack	REF
CHROMAFIL[®]								
A-20/25	0.20	25	yellow	yellow	100	729006	400	729006.400
A-45/25	0.45	25	colorless	yellow	100	729004	400	729004.400

Cellulose acetate (CA)



★ Key features

- Hydrophilic membrane
- For the filtration of water-soluble oligomers and polymers, especially suited for biological macromolecules
- Very high shape stability in aqueous solutions
- Extremely low binding capacity for proteins (21 µg / 25 mm filter)
- Also available in a sterile package (S) for filtration under sterile conditions (each filter individually sealed)

Ordering information

Type	Pore size [µm]	Membrane diameter [mm]	Standard pack		BIGbox			
			Filters/Pack	REF	Filters/Pack	REF		
CHROMAFIL[®] Xtra								
CA-20/13	0.20	13	labeled	100	729254			
CA-45/13	0.45	13	labeled	100	729255			
CA-20/25	0.20	25	labeled	100	729226	400	729226.400	
CA-45/25	0.45	25	labeled	100	729227	400	729227.400	
Type	Pore size [µm]	Membrane diameter [mm]	Color code		Standard pack		BIGbox	
			Top	Bottom	Filters/Pack	REF	Filters/Pack	REF
CHROMAFIL[®]								
CA-20/15 MS	0.20	15	yellow	red	100	729054		
CA-45/15 MS	0.45	15	colorless	red	100	729055		
CA-20/25	0.20	25	yellow	red	100	729026	400	729026.400
CA-45/25	0.45	25	colorless	red	100	729027	400	729027.400
Sterile filters								
CA-20/25 (S)	0.20	25	yellow	red	50	729024		
CA-45/25 (S)	0.45	25	colorless	red	50	729025		

MS = minispikes on filter exit; S = sterile filters

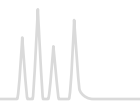

Polyamide (PA) = Nylon



★ Key features

- Rather hydrophilic membrane
- For aqueous and organic-aqueous medium polar liquids

Ordering information

Type	Pore size [µm]	Membrane diameter [mm]	Standard pack		BIGbox			
			Filters/Pack	REF	Filters/Pack	REF		
CHROMAFIL[®] Xtra								
PA-20/13	0.20	13	labeled	100	729248			
PA-45/13	0.45	13	labeled	100	729249			
PA-20/25	0.20	25	labeled	100	729212	400	729212.400	
PA-45/25	0.45	25	labeled	100	729213	400	729213.400	
Type	Pore size [µm]	Membrane diameter [mm]	Color code		Standard pack		BIGbox	
			Top	Bottom	Filters/Pack	REF	Filters/Pack	REF
CHROMAFIL[®]								
AO-20/3	0.20	3	colorless	colorless	100	729010		
AO-45/3	0.45	3	colorless	colorless	100	729011		
AO-20/15 MS	0.20	15	yellow	green	100	729048		
AO-45/15 MS	0.45	15	colorless	green	100	729049		
AO-20/25	0.20	25	yellow	green	100	729012	400	729012.400
AO-45/25	0.45	25	colorless	green	100	729013	400	729013.400

MS = minispikes on filter exit

Polyethersulfone (PES)



★ Key features

- Hydrophilic membrane
- For aqueous liquids and aqueous liquids with low organic contents
- Very low adsorption of pharmaceuticals and proteins
- Good stability against acids and bases
- Binding capacity for proteins 29 µg per 25 mm filter

Ordering information

Type	Pore size [µm]	Membrane diameter [mm]	Standard pack		BIGbox		
			Filters/Pack	REF	Filters/Pack	REF	
CHROMAFIL[®] Xtra							
PES-20/25	0.20	25	labeled	100	729240		
PES-45/25	0.45	25	labeled	100	729241	400	729241.400
PES-500/25	5.0	25	labeled	100	729242		



Polyvinylidene difluoride (PVDF)



★ Key features

- Hydrophilic membrane
- For 100 % aqueous samples, water-soluble oligomers and polymers like proteins
- Binding capacity for proteins 20 µg per 25 mm filter

Ordering information

Type	Pore size [µm]	Membrane diameter [mm]		Standard pack		BIGbox	
				Filters/Pack	REF	Filters/Pack	REF
CHROMAFIL® Xtra							
PVDF-20/13	0.20	13	labeled	100	729243		
PVDF-45/13	0.45	13	labeled	100	729244		
PVDF-20/25	0.20	25	labeled	100	729218	400	729218.400
PVDF-45/25	0.45	25	labeled	100	729219	400	729219.400

Type	Pore size [µm]	Membrane diameter [mm]	Color code		Standard pack			
			Top	Bottom	Filters/Pack	REF		
CHROMAFIL®								
PVDF-20/15 MS	0.20	15	yellow	white	100	729043		
PVDF-45/15 MS	0.45	15	colorless	white	100	729044		

MS = minispikes on filter exit

Glass fiber (GF)

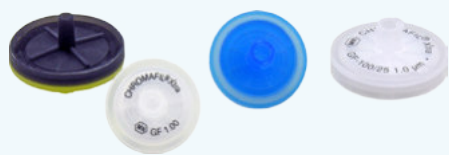

★ Key features

- Inert filter, nominal pore size 1 µm, allows higher flow rates than small pore filters
- For solutions with high loads of particulate matter or for highly viscous solutions (e.g., soil samples, fermentation broths). Glass fiber exhibits a high protein-binding capacity.
- As prefilters for other CHROMAFIL® filters, they prevent plugging of the membrane

Ordering information

Type	Pore size [µm]	Membrane diameter [mm]		Standard pack		BIGbox	
				Filters/Pack	REF	Filters/Pack	REF
CHROMAFIL® Xtra							
GF-100/13	nominal 1.0	13	labeled	100	729234		
GF-100/25	nominal 1.0	25	labeled	100	729228	400	729228.400

Type	Pore size [µm]	Membrane diameter [mm]	Color code		Standard pack		BIGbox	
			Top	Bottom	Filters/Pack	REF	Filters/Pack	REF
CHROMAFIL®								
GF-100/15 MS	nominal 1.0	15	blue	colorless	100	729034		
GF-100/25	nominal 1.0	25	yellow	black	100	729028	400	729028.400

MS = minispikes on filter exit

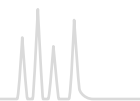

Special filter for ion chromatography (IC)



★ Key features

- For the filtration of aqueous liquids
- For optimal results with blind values < 5 ppb we recommend to prewash the filter with deionized water

Ordering information

Type	Pore size [µm]	Membrane diameter [mm]		Standard pack	
				Filters/Pack	REF
CHROMAFIL[®] Xtra					
IC-45/25	0.45	25	labeled	100	729258

Hints for using CHROMAFIL[®] syringe filters

For optimum filtration results we recommend to keep the following in mind:

- Either discard the first mL or rinse the filter unit with 1 mL of the solvent prior to filtration
- Before filling the syringe, draw about 1 mL air into the syringe in order to minimize the liquid remaining in the filter
- Start filtration with a slight pressure; this will optimize the throughput of the filter. As soon as particles accumulate on the filter, filtration will become more difficult and the pressure on the filter will increase.
- Change the filter whenever the resistance becomes too large in order to prevent rupture of the housing
- Do not apply CHROMAFIL[®] syringe filters on humans; they are only intended for lab use!
- Always use syringes ≥ 10 mL; smaller syringes can easily cause pressures above the 6 bar limit of the filters
- The temperature should not exceed 55 °C
- Do not re-use the filters

Disposable syringes with Luer tip



★ Key features

- Body and piston made from polypropylene (non sterile)

Ordering information

Volume	Pack of	REF
2 mL	100	729100
5 mL	100	729101
10 mL	100	729102



Chemical compatibility of filter materials

The chemical compatibility depends on several parameters such as time, pressure, temperature and concentration. In most cases, CHROMAFIL® filters will have only short contact with a solvent. In these cases they may be used despite of limited compatibility.

For example, a PTFE filter with PP housing does not liberate any UV-detectable substances during filtration of 5 mL THF, although PP shows only limited resistance towards THF.

The following table lists the chemical compatibility of our CHROMAFIL® materials.

Solvent	Material											
	MV	CA	RC	PA	PTFE	H-PTFE	PVDF	PES	PET	GF	IC	PP
Acetaldehyde	-	-	+	○	+	+	+	+	+	+		○
Acetic acid, 100 %	-	-	-	-	+	+	+	+	+	+		+
Acetone	-	-	+	+	+	+	-	-	+	+		+
Acetonitrile	-	-	+	+	+	+	+	+	+	+		+
Ammonia, 25 %	-	-	○	-	+	+	+	+	○	+	-	+
Benzene	+	+	+	+	+	+	○	+	+	+		○
n-Butanol	+	+	+	○	+	+	+	+	+	+		+
Cyclohexane	+	+	+	○	+	+	+	+	+	+		+
Dichloromethane	+	-	+	-	+	+	+	-	+	+		-
Diethyl ether	○	○	+	+	+	+	+	+	+	+		○
Dimethylformamide	-	-	○	+	+	+	-	-	+	+		+
1,4-Dioxane	-	-	+	+	+	+	○	-	+	+		○
Ethanol	-	+	+	+	+	+	+	+	+	+		+
Ethyl acetate	-	-	+	+	+	+	+	+	+	+		○
Ethylene glycol	○	○	+	+	+	+	+	+	+	+		+
Formic acid, 100 %	+	-	○	-	+	+	+	+	○	+		+
Hydrochloric acid, 30 %	-	-	-	-	+	+	+	+	-	+	-	+
Methanol	-	-	+	+	+	+	+	+	+	+		+
Nitric acid, 65 %	-	-	-	-	○	+	○		○	+	-	-
Oxalic acid, 10 % aqueous	+	-	+	-	+	+	+		+	+		+
Petroleum ether	+	+	+	+	+	+	+	+	+	+		+
Phosphoric acid, 80 %	-	-	○	-	+	+	○		+	+	-	+
Potassium hydroxide, 1 mol/L	-	-	○	+	+	+	○	○	○	+	+	+
2-Propanol	+	+	+	+	+	+	+	+	+	+		+
Sodium hydroxide, 1 mol/L	-	-	○	+	+	+	○	○	○	○	+	+
Tetrachloromethane	+	-	+	+	+	+	○		+	+		○
Tetrahydrofuran	-	-	+	○	+	+	+	-	+	+		○
Toluene	+	-	+	+	+	+	+	+	+	+		○
Trichloroethene	+	+	+	○	+	+	+	○	+	+		○
Trichloromethane (chloroform)	+	-	+	-	+	+	+	-	+	+		-
Urea	+	+	+	+	+	+	+		+	+		+
Water	+	+	+	+	+	+	+	+	+	+	+	+
Xylene	+	+	+	+	+		○	○	+	+		○

Data not guaranteed.

+ resistant, - not resistant, ○ limited resistance

Material

Membranes

MV = cellulose mixed esters, CA = cellulose acetate, RC = regenerated cellulose, PA = polyamide, PTFE = polytetrafluoroethylene, H-PTFE = hydrophilized polytetrafluoroethylene, PVDF = polyvinylidene difluoride, PES = polyethersulfone, PET = polyester, GF = glass fiber, IC = special filter for ion chromatography

Housing material

PP = polypropylene

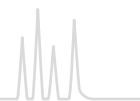

CHROMAFIL® filtration cartridges



★ Key features

- Filtration cartridges for sample clarification under vacuum (e.g., using the CHROMABOND® vacuum manifold or SPE automation systems like Gilson ASPEC™, Rapidtrace®) or by gravity
- Cartridge sizes 3 mL and 6 mL
- Different membranes (PET, RC, PTFE, PVDF, GF) and pore sizes (0.2, 0.45 and 1.0 µm). Membrane materials correspond to the respective CHROMAFIL® syringe filters.

Ordering information

Description	Pore size [µm]	Pack of [cartridges]	Column volume	
			3 mL	6 mL
CHROMAFIL® filtration cartridges				
Filtration cartridges PET (polyester)	0.20	100	730578.320	730578.620
Filtration cartridges PET (polyester)	0.45	100	730578.345	730578.645
Filtration cartridges RC (regenerated cellulose)	0.20	100	730068.320	730068.620
Filtration cartridges RC (regenerated cellulose)	0.45	100	730068.345	730068.645
Filtration cartridges PTFE (polytetrafluoroethylene)	0.20	100	730570.320	730570.620
Filtration cartridges PTFE (polytetrafluoroethylene)	0.45	100	730570.345	730570.645
Filtration cartridges PVDF (polyvinylidene difluoride)	0.20	100	730579.320	730579.620
Filtration cartridges PVDF (polyvinylidene difluoride)	0.45	100	730579.345	730579.645
Filtration cartridges GF (glass fiber)	nom. 1.0	100	730517.3100	730517.6100

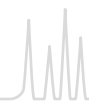

CHROMAFIL® MULTI 96 filter plates

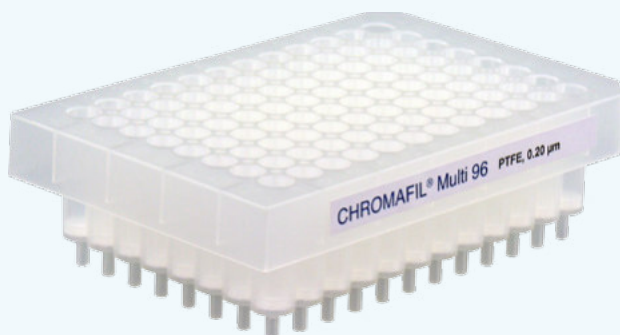

★ Key features

- 96-well polypropylene plates for the simultaneous filtration of 96 samples
- Advantages of this high-throughput system are:
 - Economical by saving time and solvent
 - The use of multi-channel pipettors facilitates liquid transfer steps
 - Readily adaptable to all common automated and robotic handling systems
 - Minimized dead volume ($\leq 40 \mu\text{L}$)
- Membrane materials correspond to the respective CHROMAFIL® syringe filters

Ordering information

Description	Pack of	REF
CHROMAFIL® MULTI 96 Filter plates		
Filter plates with cellulose mixed ester filter elements (0.20 μm)	1	738770.M
Filter plates with cellulose mixed ester filter elements (0.45 μm)	1	738771.M
Filter plates with RC filter elements (regenerated cellulose 0.2 μm)	1	738656.M
Filter plates with RC filter elements (regenerated cellulose 0.45 μm)	1	738657.M
Filter plates with PTFE filter elements (0.2 μm)	1	738660.M
Filter plates with PTFE filter elements (0.45 μm)	1	738661.M
Filter plates with PTFE filter elements (1.0 μm)	1	738662.M
Filter plates with PTFE filter elements (3.0 μm)	1	738663.M
Filter plates with PE filter elements (20 μm)	1	738655.M
Filter plates with PE filter elements (50 μm)	1	738659.M
Filter plates with glass fiber filter elements (nominal 1 μm)	1	738655.2M
Filter plates with glass fiber filter elements (nominal 3 μm)	1	738658.M
CHROMABOND® MULTI 96 vacuum manifold for monoblocks, with reservoir tank, vacuum gauge and control valve, for filtration with 96-well filter plates	1	738630.M